

**FIXED SERIES 2200**

AAMA/WDMA/CSA 101/I.S.2/A440-08

Rating:	AW-PG100
Air Infiltration:	0.01 cfm/ft <sup>2</sup> at 6.2 psf
Water Resistance:	No Leakage at 15.00 psf
Structural Performance:	150.0 psf
Thermal Break:	Yes
Main Frame Depth:	2 3/8"
Glazing Thickness:	1 1/2" - Maximum

Let's Shine.

800.737.2800 • fax 417.862.1232 • [BoydAluminum.com](http://BoydAluminum.com)

©2011 Boyd Aluminum Manufacturing. The Boyd sunburst and logotype are trademarks of Boyd Aluminum Manufacturing. All rights reserved. Due to continued product research, specifications are subject to change without notice.

**G5-1**  
Boyd 2012

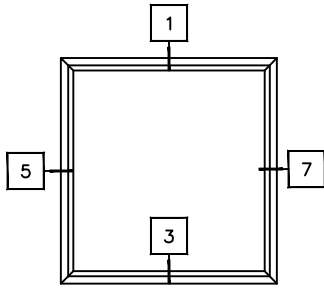

FIXED

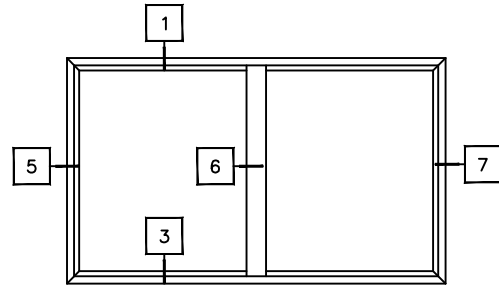

FIXED WITH TRUE MUNTIN

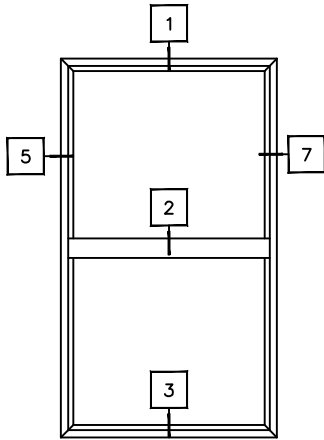

FIXED WITH TRUE MUNTIN

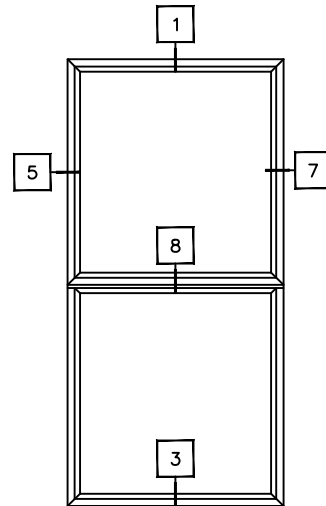

FIXED / FIXED

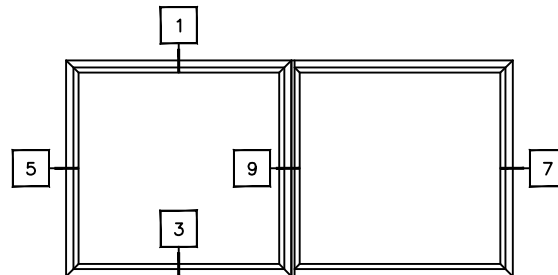

FIXED / FIXED

Let's Shine.

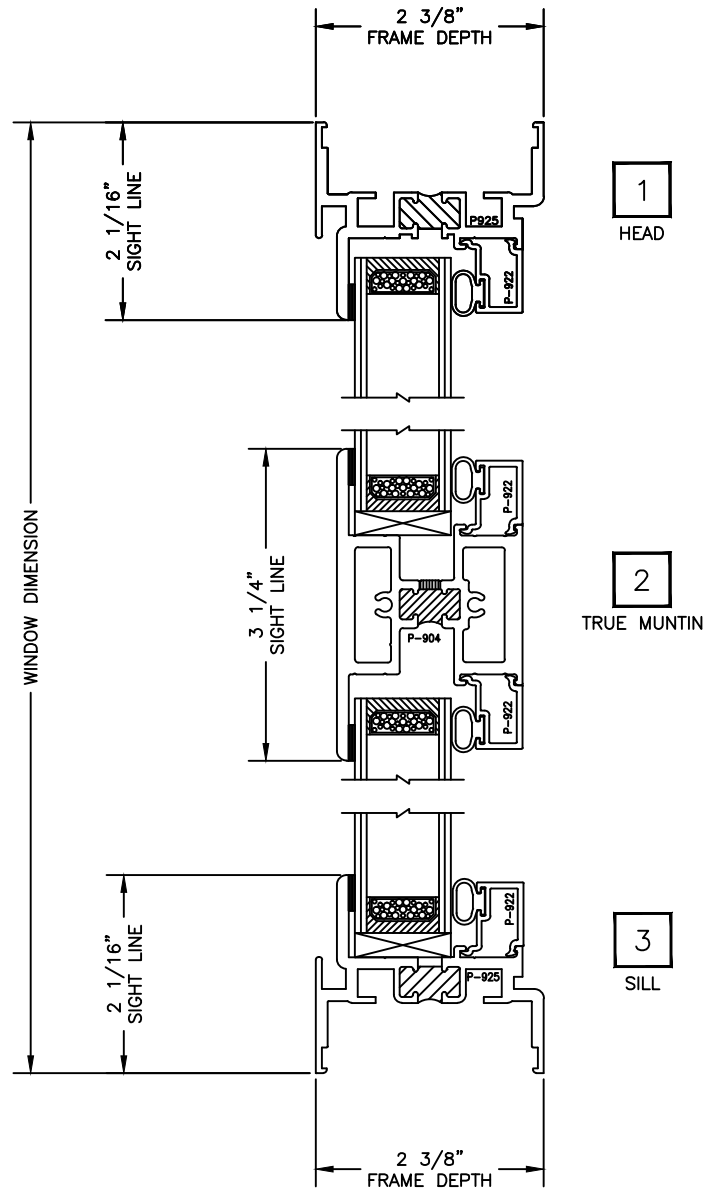

Let's Shine.

800.737.2800 • fax 417.862.1232 • [BoydAluminum.com](http://BoydAluminum.com)

©2011 Boyd Aluminum Manufacturing. The Boyd sunburst and logotype are trademarks of Boyd Aluminum Manufacturing. All rights reserved. Due to continued product research, specifications are subject to change without notice.

**G5-3**  
Boyd 2012

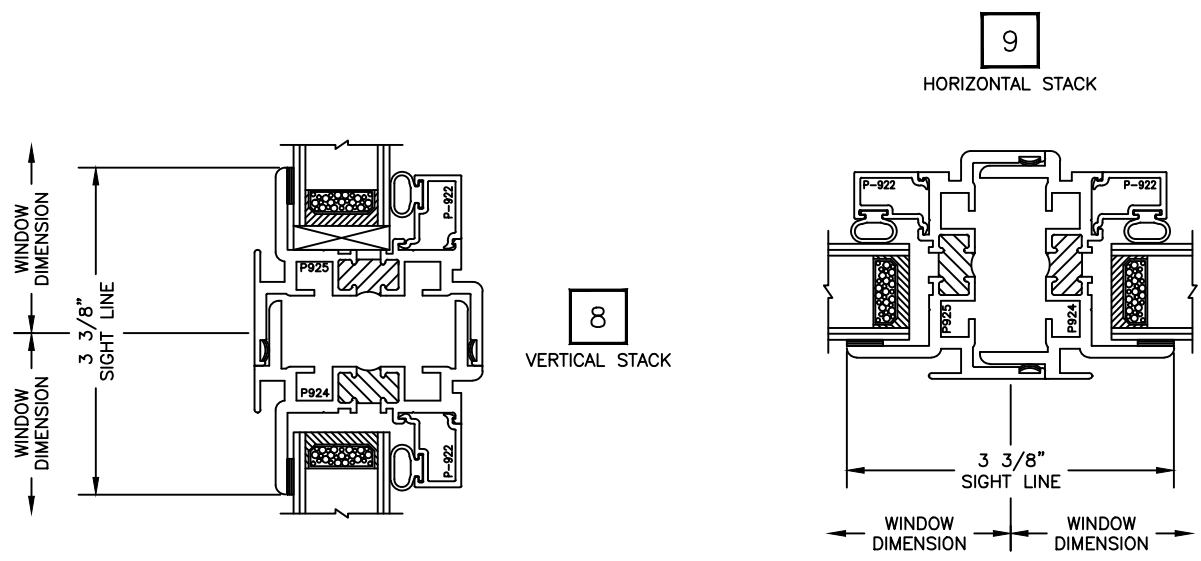
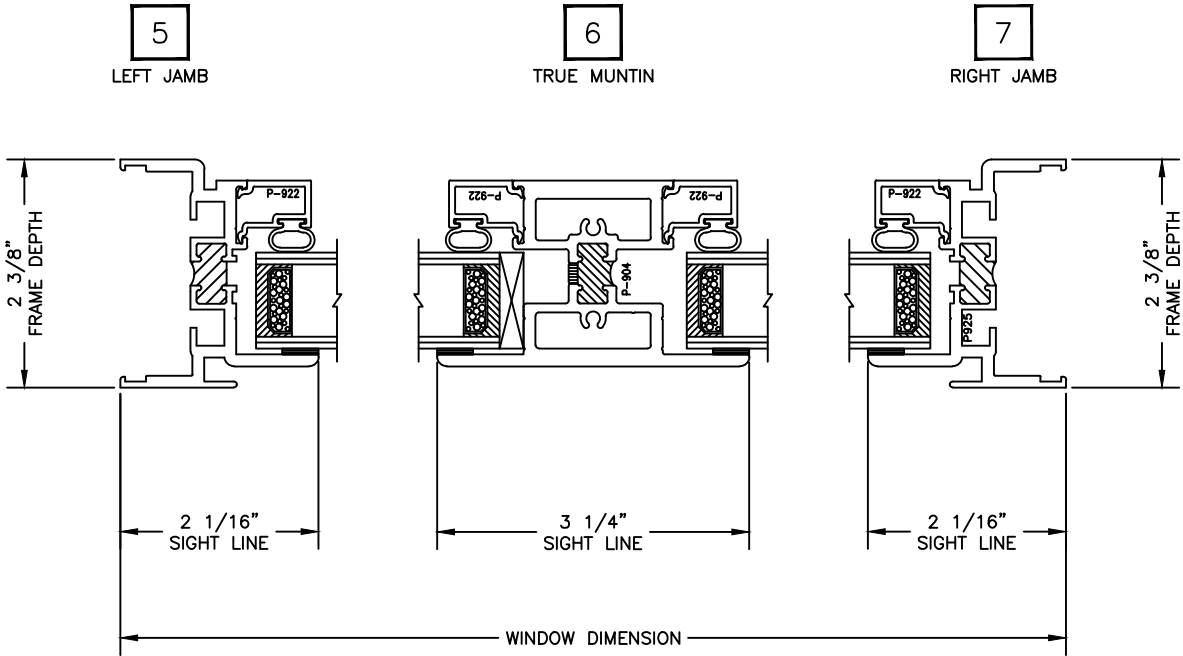

Let's Shine.

800.737.2800 • fax 417.862.1232 • [BoydAluminum.com](http://BoydAluminum.com)

©2011 Boyd Aluminum Manufacturing. The Boyd sunburst and logotype are trademarks of Boyd Aluminum Manufacturing. All rights reserved. Due to continued product research, specifications are subject to change without notice.

## Glazing Options

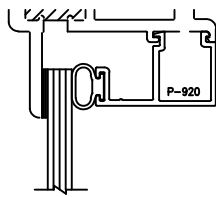

1/4" SINGLE GLAZED

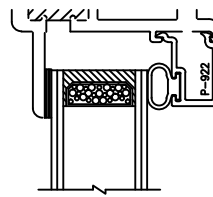

1" INSULATED GLASS

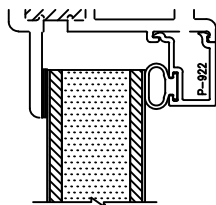

1" INSULATED PANEL

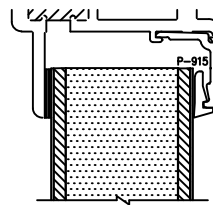

1 1/2" INSULATED PANEL

Let's Shine.

800.737.2800 • fax 417.862.1232 • [BoydAluminum.com](http://BoydAluminum.com)

©2011 Boyd Aluminum Manufacturing. The Boyd sunburst and logotype are trademarks of Boyd Aluminum Manufacturing. All rights reserved. Due to continued product research, specifications are subject to change without notice.

**G5-5**  
Boyd 2012