

FIXED SERIES 1200

AAMA/WDMA/CSA 101/I.S.2/A440-08

Rating:	FW-C90
Air Infiltration:	0.01 cfm/ft at 6.2 psf
Water Resistance:	No Leakage at 15.00 psf
Structural Performance:	135.00 psf
Thermal Break:	Yes
Main Frame Depth:	2 3/8"
Glazing Thickness:	1 1/2" -Maximum

Lets Shine.

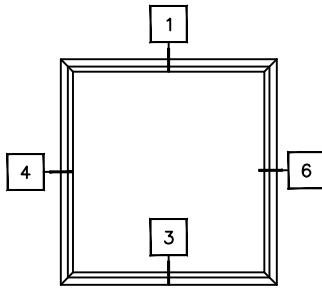

FIXED

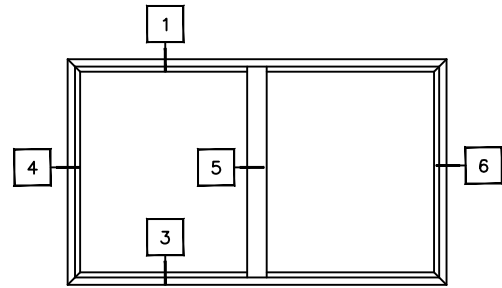

FIXED WITH TRUE MUNTIN

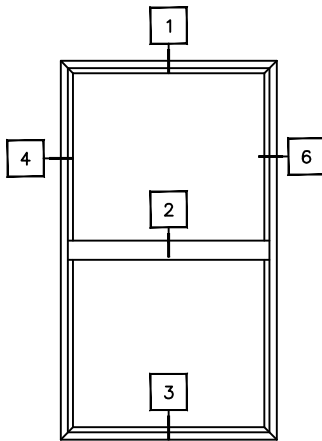

FIXED WITH TRUE MUNTIN

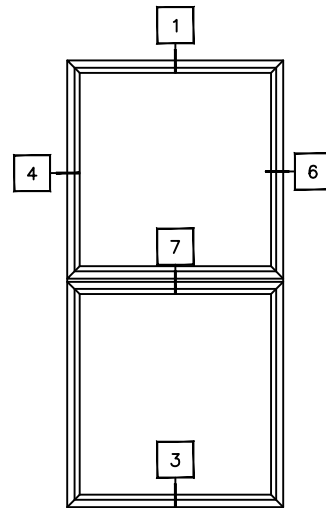

FIXED / FIXED

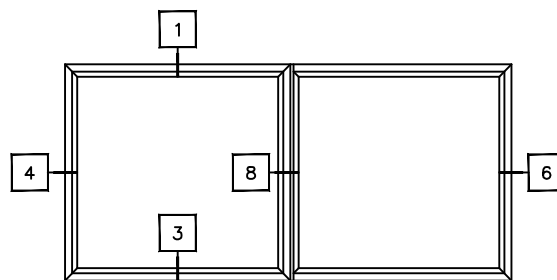

FIXED / FIXED

Let's Shine.

800.737.2800 • fax 417.862.1232 • BoydAluminum.com

©2011 Boyd Aluminum Manufacturing. The Boyd sunburst and logotype are trademarks of Boyd Aluminum Manufacturing. All rights reserved. Due to continued product research, specifications are subject to change without notice.

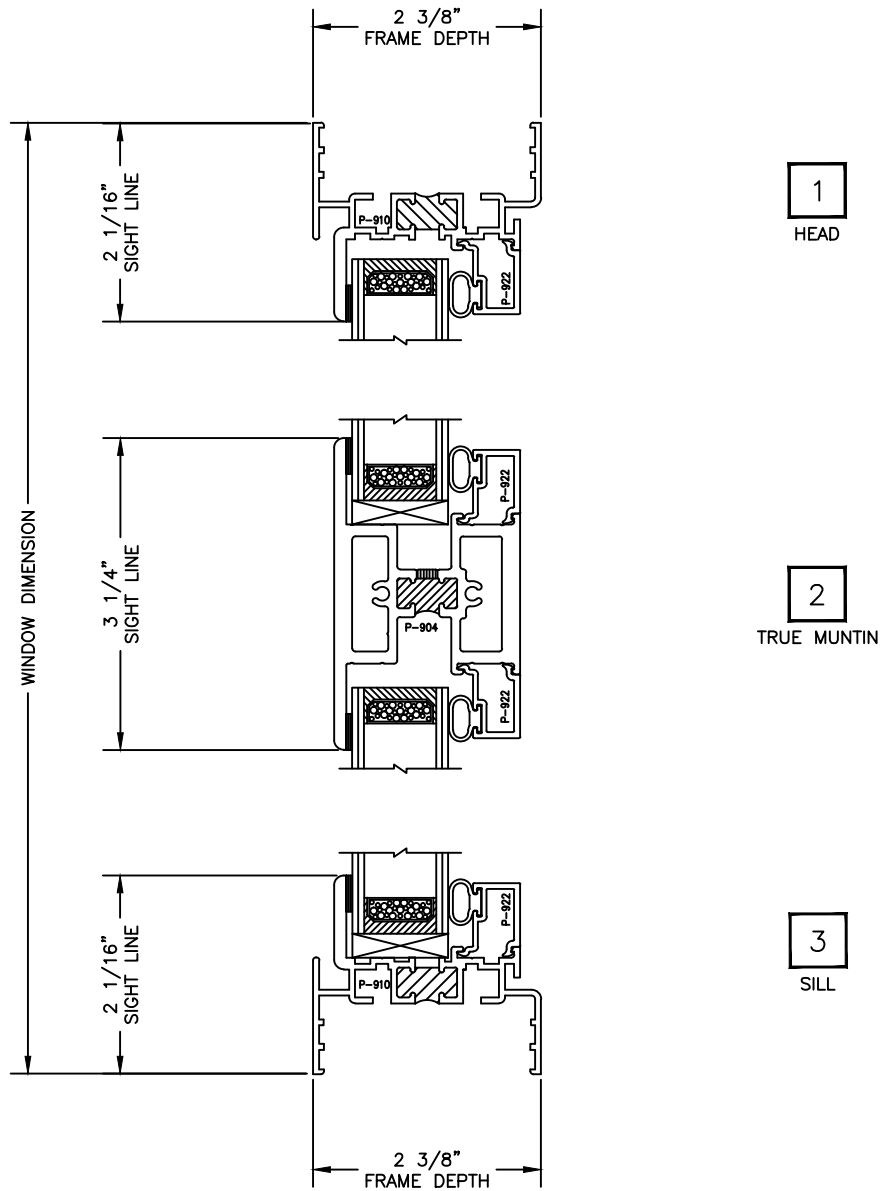

Let's Shine.

800.737.2800 • fax 417.862.1232 • BoydAluminum.com

©2011 Boyd Aluminum Manufacturing. The Boyd sunburst and logotype are trademarks of Boyd Aluminum Manufacturing. All rights reserved. Due to continued product research, specifications are subject to change without notice.

4
LEFT JAMB

5
TRUE MUNTIN

6
RIGHT JAMB

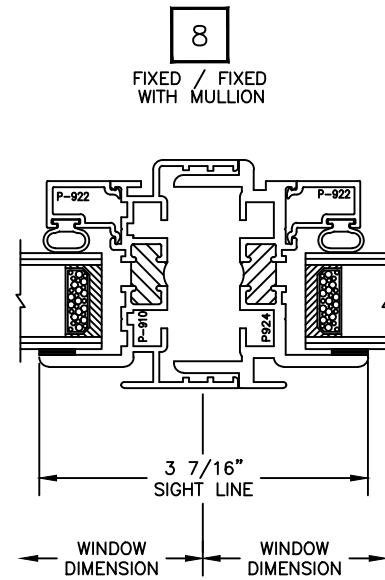
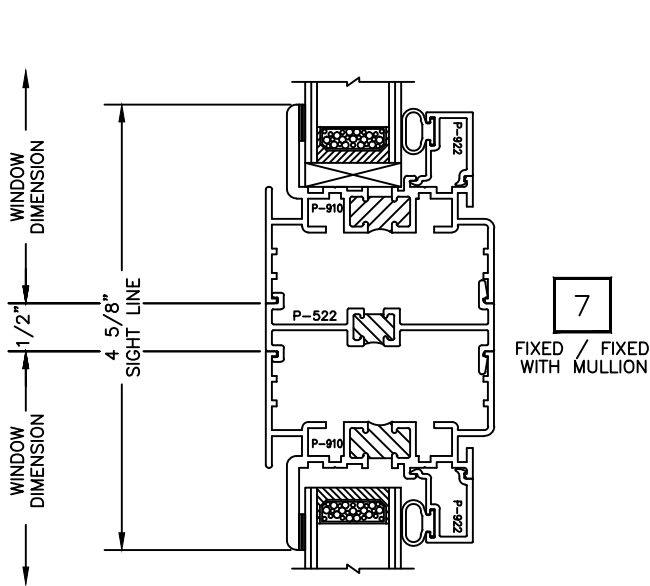
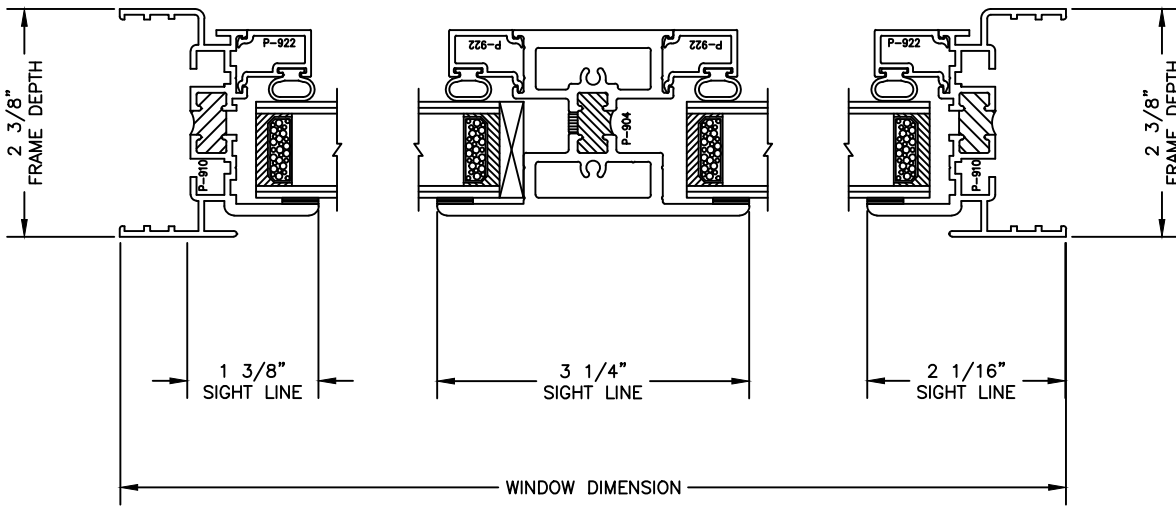

Let's Shine.

800.737.2800 • fax 417.862.1232 • BoydAluminum.com

©2011 Boyd Aluminum Manufacturing. The Boyd sunburst and logotype are trademarks of Boyd Aluminum Manufacturing. All rights reserved. Due to continued product research, specifications are subject to change without notice.

Glazing Options

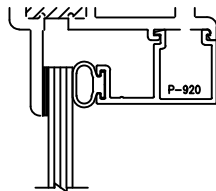

1/4" SINGLE GLAZED

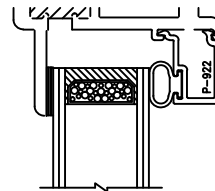

1" INSULATED GLASS

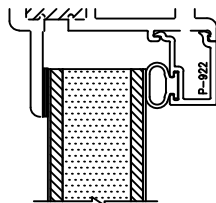

1" INSULATED PANEL

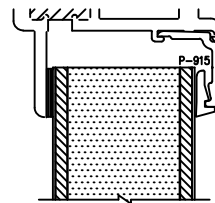

1 1/2" INSULATED PANEL

Let's Shine.

800.737.2800 • fax 417.862.1232 • BoydAluminum.com

©2011 Boyd Aluminum Manufacturing. The Boyd sunburst and logotype are trademarks of Boyd Aluminum Manufacturing. All rights reserved. Due to continued product research, specifications are subject to change without notice.